

Liquids to Value



VARIPURE Static Cleaners

for tank and vessel cleaning

Made by GEA Tuchenhagen



VARIPURE Static Cleaners - Spray Balls

GEA Tuchenhagen offers a comprehensive product range for almost all cleaning tasks.

All VARIPURE cleaner are to the latest state-of-the-art designed and manufactured. The devices meet your high hygiene claims considered by the geometrical shape and the best surface texture. These parameters proven best meet the requirements to use our cleaners in the brewing and beverage industries, in the cosmetic and pharmaceutical, chemical, paint and coatings as well as in the biotechnology industry.

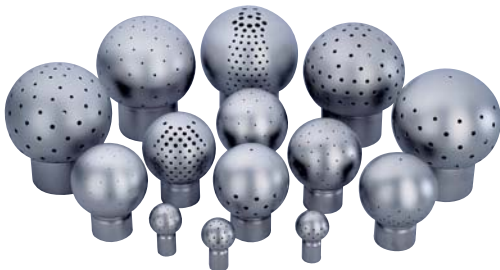

Spray balls, dull



Spray balls, ground $R_a \leq 0.8 \mu\text{m}$



Spray balls, polished $R_a \leq 0.8 \mu\text{m}$

Application

For low pressure internal cleaning of Vessels, Tanks, Containers of all kinds, Machines

Method of Operation

Cleaning is achieved by intensive wetting and rinsing of the tank wall. By dosing appropriate detergents, the cleaning effect can be enhanced and the cleaning times reduced.

Two operating modes are possible:

- continuous spraying for media which can easily be washed off
- pulse-pause operation for media which require a reaction time. Pulse-pause operation reduces the quantity of CIP medium.

The spray balls with slip-on connection give a small annular gap between the spray ball sleeve and insertion pipe outer diameter allowing this area to be cleaned during operation.

Design

Fixed by:

- slip-on connections secured with clip
- threaded sleeve

Material

1.4404/316L (standard), 1.4435/316L, Alloy 59/2.4605

Dimensions of pipes

Type 05, DN 10 — Type 1, DN 25 — Type 2, DN 50

VARIPURE Static Cleaners - Spray Balls

Sprayballs with pipe clip and threaded connection

Material

1.4404 / 316L - Connection to pipe acc. to DIN 11850, Inch OD and threaded connection acc. to DIN ISO 228-1

1.4435 / 316L Fe ≤ 1% - Connection to pipe acc. to DIN 11850, ISO 1127, polished (outside surface Ra ≤ 0.8 μm)

2.4605 (Alloy 59) - Connection to pipe acc. to Inch OD, ISO 1127 and threaded connection to ISO 228-1, polished (outside surface Ra ≤ 0.8 μm)

Type	Spraying angle	Cleaning circle diameter [m]	Dimensions		Flow rate Connection: Pipe clip					Flow rate Connection: Threaded conn.	
			D [mm]	H [mm]	[m³/h] bei 1 bar	DIN da [mm]	Zoll OD da [mm]	DIN / ISO da [mm]	OD / ISO da [mm]	[m³/h]	G
A 05	360°	1.0 - 2.0	28	45	5.1	12 / 13	1/2" (12.7)	13.5	1/2" (12.7)	4.7	G 1/4" *
A 05-1.0	360°	0.8 - 1.5	28	45	2.8	12 / 13	1/2" (12.7)	13.5	1/2" (12.7)	2.4	G 1/4" *
A 1-1.0	360°	1.5 - 2.5	64	85	3	29	1" (25.4)	29 / 33.7	33.7	2.5	G 1"
A 1-1.5	360°	1.8 - 3.0	64	85	7	29	1" (25.4)	29 / 33.7	33.7	6.5	G 1"
A 1	360°	2.0 - 3.0	64	85	9.8	29	1" (25.4)	29 / 33.7	33.7	9.4	G 1"
A 1-1	360°	2.5 - 3.5	64	85	12.8	29	1" (25.4)		33.7	12.3	G 1"
A 1-2	360°	3.0 - 4.0	64	85	15.3	29	1" (25.4)		33.7	14.8	G 1"
A 2	360°	3.5 - 5.0	93	115	21.9	53	2" (50.8)			20.9	G 2"
A 2-1	360°	4.0 - 6.0	93	115	28.4	53	2" (50.8)			27.4	G 2"
A 2-2	360°	5.0 - 7.0	93	115	35.6	53	2" (50.8)			34.6	G 2"
A 2-3	360°	6.0 - 8.0	93	115	40.9	53	2" (50.8)			39.9	G 2"
B 05	192°	1.0 - 2.0	28	45	3	12 / 13	1/2" (12.7)			2.5	G 1/4" *
B 1	192°	2.0 - 3.0	64	85	9.5	29	1" (25.4)			9	G 1"
B 2	194°	3.5 - 5.0	93	115	22.4	53	2" (50.8)			21.4	G 2"
B 2-3	194°	6.0 - 8.0	93	115	42.2	53	2" (50.8)			41.2	G 2"
G 05	232°	1.0 - 2.0	28	45	4.7	12 / 13	1/2" (12.7)			4.2	G 1/4" *
G 1	206°	2.0 - 3.0	64	85	9.2	29	1" (25.4)			8.7	G 1"
G 1-1	206°	2.5 - 3.5	64	85	11.2	29	1" (25.4)			10.7	G 1"
G 1-2	206°	3.0 - 4.0	64	85	14.5	29	1" (25.4)			14	G 1"
G 2	246°	3.5 - 5.0	93	115	20.1	53	2" (50.8)			19.1	G 2"
G 2-1	246°	4.0 - 6.0	93	115	26.8	53	2" (50.8)			25.8	G 2"
G 2-2	246°	5.0 - 7.0	93	115	34.7	53	2" (50.8)			33.7	G 2"
G 2-3	246°	6.0 - 8.0	93	115	41	53	2" (50.8)			40	G 2"
L 1	188°	2.5 - 3.0	64	85	8.6	29	1" (25.4)		33.7	8.1	G 1"
L A1-1.0	360°	1.5 - 2.5	64	85	5.5	29	1" (25.4)	29 / 33.7	33.7		
L A1-1.5	360°	2.5 - 3.0	64	85	11	29	1" (25.4)	29 / 33.7	33.7		

* Dimensions for spray balls type 05 with thread made of 1.4404; D=28, H=25

Conversion formula for other flow rates: $Q_2 = Q_1 \times \sqrt{(p_2/p_1)}$ [m³/h]

Recommended operating pressure 1.0 to 1.5 bar, for agitator tanks 1.8 up to max. 2.5 bar

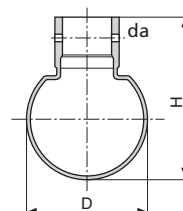

VARIPURE Static Cleaners - Spray Balls

Spray patterns and spray balls

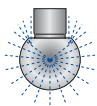
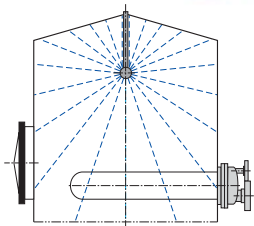

Spray pattern A
for vertical tanks
with tank
internals

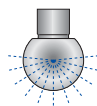
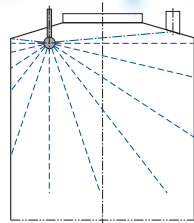

Spray pattern B
for vertical tanks
with sockets open at
the top

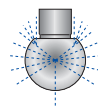
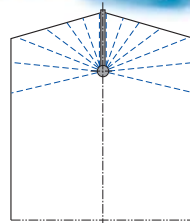

Spray pattern G
for vertical tanks

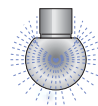
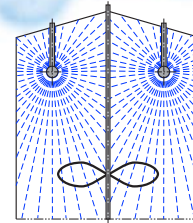

Spray pattern LA
for vertical tanks

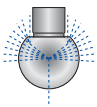
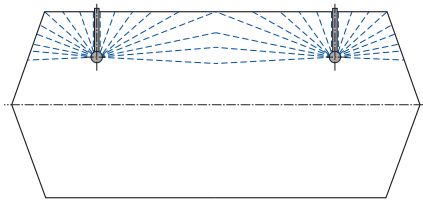

Spray pattern L
for horizontal tanks

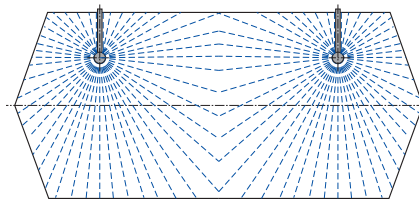

Spray pattern LA
for horizontal tanks

Cleaning Lances for low pressure internal cleaning of tanks

Features

- Simple operation for effective and reliable cleaning
- Customised adaptation to all cleaning requirements
- Self cleaning of the cleaning lance segment projecting into the tank, including tank connection

Application

For low pressure internal cleaning of Vessels, Tanks, Containers of all kinds, Machines

Insertion lengths

Insertion lengths available in steps of 100 mm

Type 05 from 100 to 400 mm

Type 1 from 100 to 800 mm

Type 2 from 100 to 1,000 mm

Material

Stainless steel 316L (1.4404)

Standard connections

A without tank connection (weld-in type)

A VARIVENT® groove flange

A VARIVENT® cover 50/40 for Type 0.5 and 1

A Liner/groove nut acc. to DIN 11851

C Clamp connection DN 50 for Type 1 and 2

D Welded end

D VARIVENT® groove flange

D Male part acc. to DIN 11851

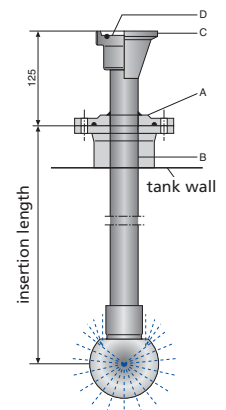

A = Tank connection
B = Connection socket
C+D = Pressure connection

VARIPURE Static Cleaners - In-Line Sprayer IS 25

VARIPURE In-Line Sprayer IS 25 is fitted with a spray head that is extended into the tank or pipe for cleaning.

Decisive advantage:

After the cleaning operation, the spray head is retracted to its resting place and is flush with the tank/pipe wall; the spray head no longer projects into the product chamber.

The In-Line Sprayer helps you significantly reducing cleaning costs as it dispenses with the need to accumulate cleaning solution in agitator tanks or to flood the pipes.



Characteristics of the VARIPURE In-Line Sprayer

1. Electrical components in the control module are fully splash-water protected (up to IP67).
2. Sturdy and reversible actuator – spring-to-close/air-to-open or vice versa. Air backup of the spring is possible.
3. ECOVENT® actuator
4. The open lantern separates the actuator from the product section of the valve. It permits the visual inspection of the spindle seal.
5. The machine rolled valve spindle finish provides for excellent wiping action as it passes through the seal, ensuring long life of the stem seal.
6. Housing with one or two sockets.
7. The metallic stop of the valve disk provides a defined deformation of the seal, ensuring long seal life.
8. Seat ring and guide for the spray head.
9. Retractable spray head
10. Easy to fit and remove due to the hinged clamp.

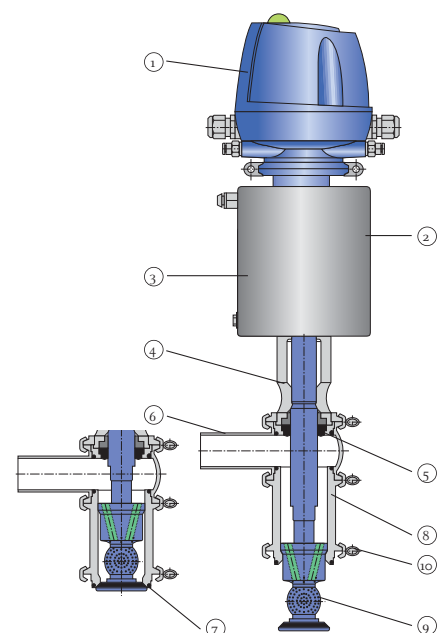

VARIPURE Static Cleaners - In-Line Sprayer IS 25



Pipe and tank connections



Housing connection IS-T for welding into the tank shell



VARINLINE® housing connection
from DN 80 up to DN 150, 4" OD and 6" IPS



Housing connection IS raw for welding into pipes from
DN 200 up to DN 400



Housing connection T 50/40 for welding into tank
bottoms or tank shells

Advantages

- As the spray head does not project into the product chamber it cannot constitute a source of contamination during production
- Gap-free seal
- Especially suitable for installation in pipes, tank shells and VARIVENT® In-Line housing

Control and feedback systems

The valves can be equipped with the well-established GEA Tuchenhagen control and feedback systems.



Proximity switch holder with
two proximity switches



T.VIS® control system

VARIPURE Static Cleaners - In-Line Sprayer IS 25

Areas of application and cleaning angles

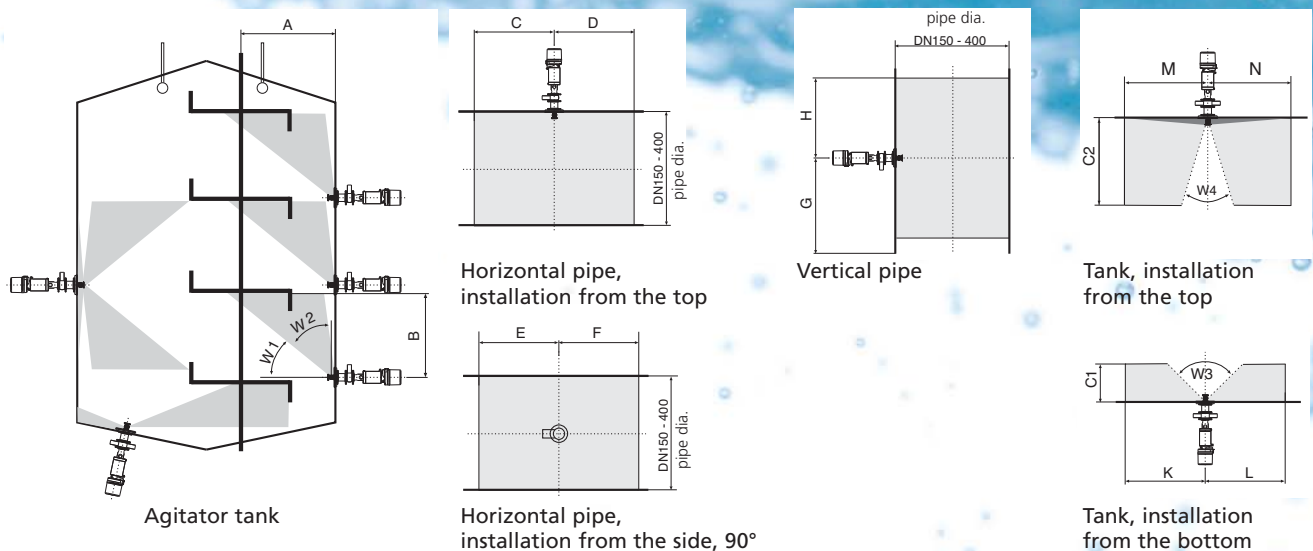

Data in [mm and °]	A	B	W1	W2	C	D	E	F	G	H	K	L	C1	W3	M	N	C2	W4
Spray hole B 0,6 mm	1,000	1,200	48°	34°	800	800	700	700	2.000	300	900	900	800	98°	900	900	2,000	90°
Spray hole B 0,8 mm	1,500	1,500	48°	34°	800	800	700	700	2.500	700	900	900	800	98°	900	900	2,000	90°

Two types of spray heads are available:

Spray head B 06 (all holes 0.6 mm)

Spray head B 08 (all holes 0.8 mm)

Flow rates (optimum operating pressure 1.8 to 2.5 bar)

Pressure [bar]	1.5	1.8	2.0	2.2	2.5
Flow rate B 0.6 [m³/h]	2.9	3.2	3.4	3.5	3.8
Flow rate B 0.8 [m³/h]	4.2	4.6	4.8	5.1	5.4

Technical characteristics

- Operationally safe and reliable
- Spring-actuated closing and pneumatic opening
- Vacuum resistant up to 0.1 bar abs.
- Feedback via control module
- Feedback via mounting for proximity switches
- ATEX zone 0G/20D possible
- Product contacted seals (FDA)
 - EPDM
 - FKM
 - FFKM (resistant to solvents)
- Cleaning temperature max. 98 °C
- Can be steamed for 30 min. at 140 °C
- Material 1.4435/316L
- Material certificates for product contacted parts according to EN10204-2.2 and EN10204-3.1
- Product contacted surfaces $Ra \leq 0.8 \mu m$
- Pipe connection dimensions according to
 - DIN 29x1.5 mm
 - ISO 33,7x2.0 mm



GEA Mechanical Equipment

GEA Tuchenhagen GmbH

Am Industriepark 2-10, 21514 Büchen, Germany

Phone +49-4155 49-0, Fax +49-4155 49-2423

sales.geatuchenhagen@geagroup.com, www.tuchenhagen.com